

DC 常规金属叶片轴流风机
DC Conventional Carbon Steel Blade Axial Fan

Erp2015
EXCEEDS THE NORM

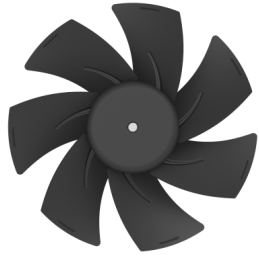

Φ 250

转子材质 Rotor Material: 碳钢 Carbon steel
风叶材质 Blade Material: 碳钢 Carbon steel
防护等级 Ingress Protection: IP42
绝缘等级 Insulation Class: F
轴承类型 Bearing Type: 免维护滚珠球轴承
Maintenance free ball bearing

性能曲线 Performance Curves

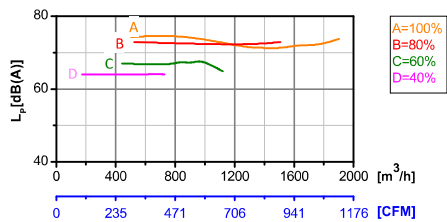
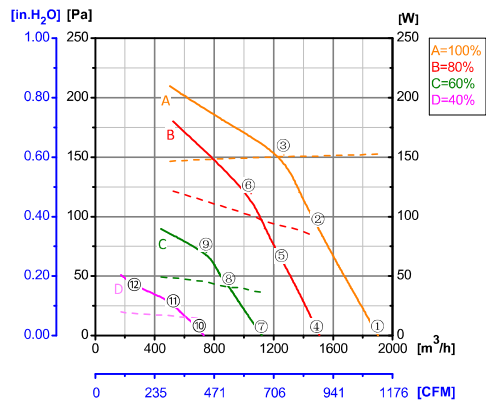

测试节点 Test Point	转速 Speed rpm	输入功率 Input Power W
1	2788	127
2	2794	122
3	2687	124
4	2234	66
5	2234	67
6	2232	70
7	1673	29
8	1673	30
9	1677	46
10	1113	10
11	1114	10
12	1112	15

Erp2015 Data:
Efficiency η_{statA} =28.6%
Efficiency grade N_{actual} =40.6, N_{target} =40
Test report No. : L-20210302 -004-022

产品型号 Model No.	电压 Voltage	频率 Frequency	转速 Speed	输入功率 Input Power	电流 Current	运行温度 Working Temp.	认证 Approvals
	VDC	Hz	RPM	W	A	Min/Max (°C)	
DC92-A250-041	24	/	2780	125	5.21	-20/+60	CE
DC92-A250-C41	48	/	2780	125	2.61	-20/+60	CCC, CE
DC92-A250-D41	310	/	2780	125	0.41	-20/+60	CCC, CE

风机本体 Type A

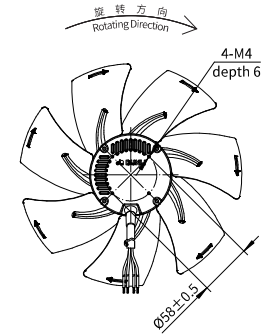
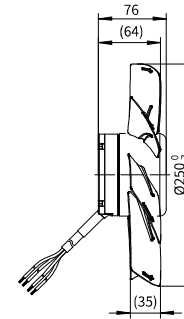

B型网罩 Type B

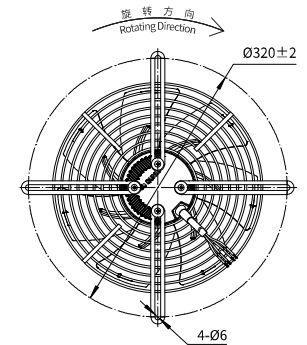
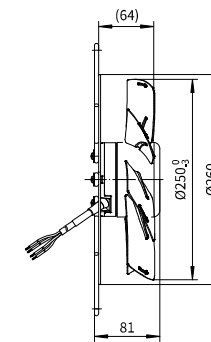

F型面板 Type F

